



Victor™

General Purpose LED Area & Flood Light

36W

FEATURES

- System Light Efficacy 130 LPW
- 3G Vibration Tested
- IP66
- Easy Installation & Maintenance
- CE, RoHs, CB
ETL/DLC Pending

SPECIFICATIONS

PERFORMANCE

LED Chip	Philips Lumileds
Efficacy(IES)	130 lm/W
Color Temperature	4000K (3000~5700K Optional)
CRI	≥70
Lumen Maintenance	L70>100,000 Hours (Calculated Using Tm-21 Calculator)
Input Voltage	100-277 VAC
Power Factor	0.95 Minimum
IK Rating	IK10
IP Rating	IP66
Surface Treatment	Corrosive resistant polyester powder coat finish
Lens Material	PC 3000U

ENVIRONMENTAL

Operating Temperature	-30 to 55°C (-22 to 131°F)
Storing Temperature	-40 to 80°C (-40 to 176°F)
Humidity	15% to 95% RH

WARRANTY



5 Years

TYPICAL APPLICATIONS

- Offset highway lighting
- Correctional facilities
- Perimeter areas
- Power plants
- Security areas
- Rail yards
- Parking lots

E-LITE semicon

■ Specifications

Picture	Part#	Power	Efficacy(IES)	Total Lumen	N.W	Product Dimensions
	EO-VIC-36	36W	130lm/W	4,680lm	4.0kg/8.8lbs	405x227x227mm 15.9x8.9x8.9in
	EO-VIC-36	36W	130lm/W	4,680lm	3.85kg/8.5lbs	365x227x227mm 14.4x8.9x8.9in

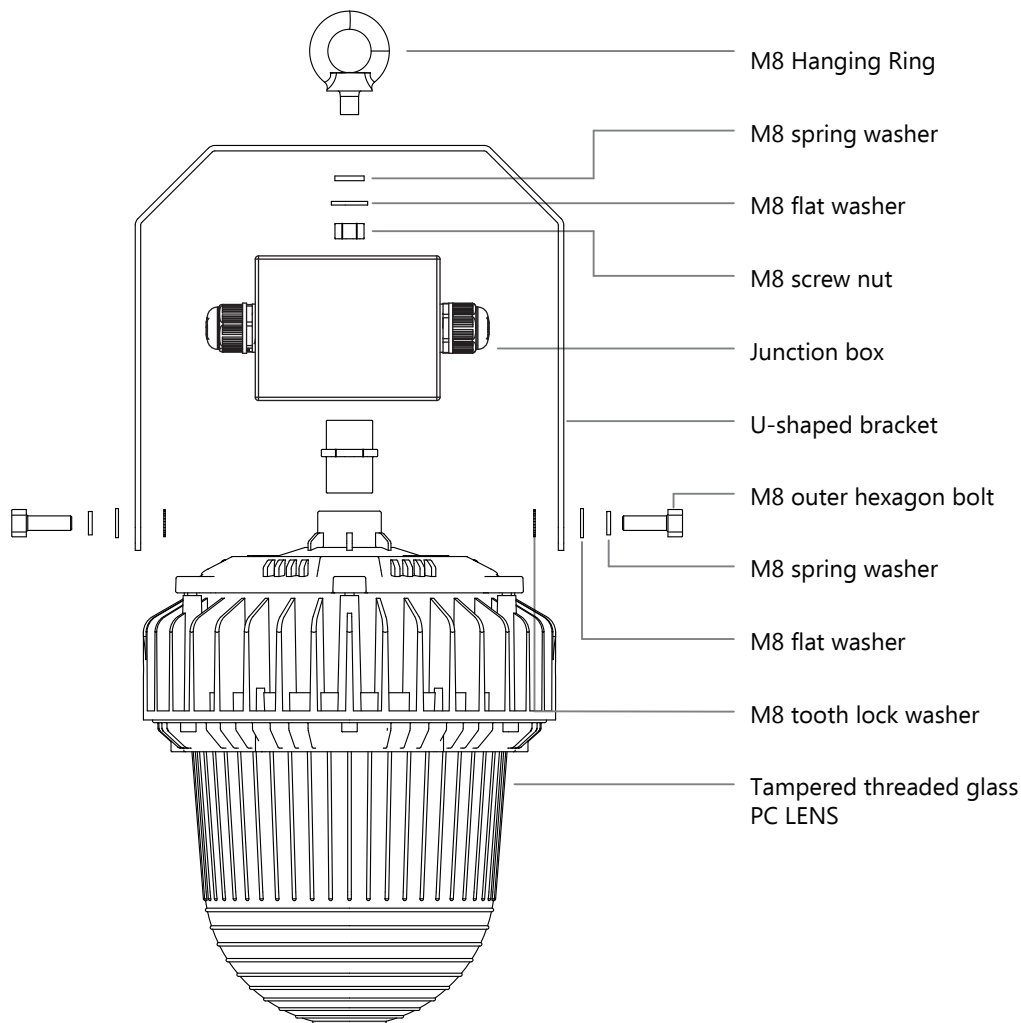

■ Photometrics

120 DEGREE (Tampere threaded glass)

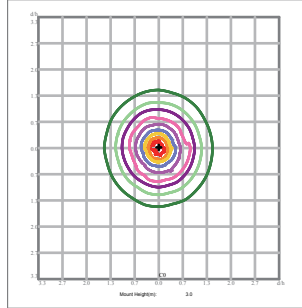
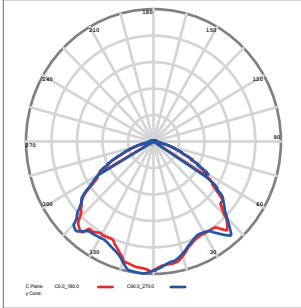

120 DEGREE(PC LENS)

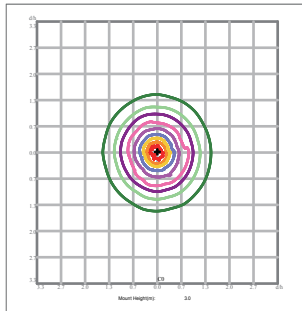
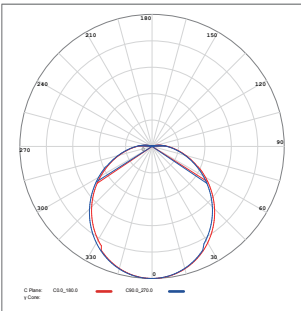

E-LITE semicon

Emergency Power Backup Options

Emergency Power Backup

Rated Voltage	AC 100-277V
Main Power Consumption	5W
Charging Time	≤24H
Emergency Time	≥90MIN
IP Rating	IP65
Operating Temperature	0℃-55℃
Switch-over Time	≤1S
Battery Specification	LI-ION/3.6V/2600mAH
UL Certificate Number	E507068
Control	Individual Control

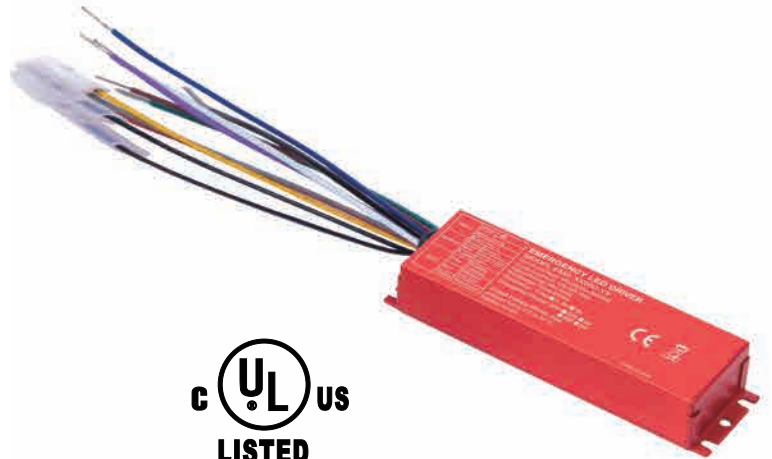

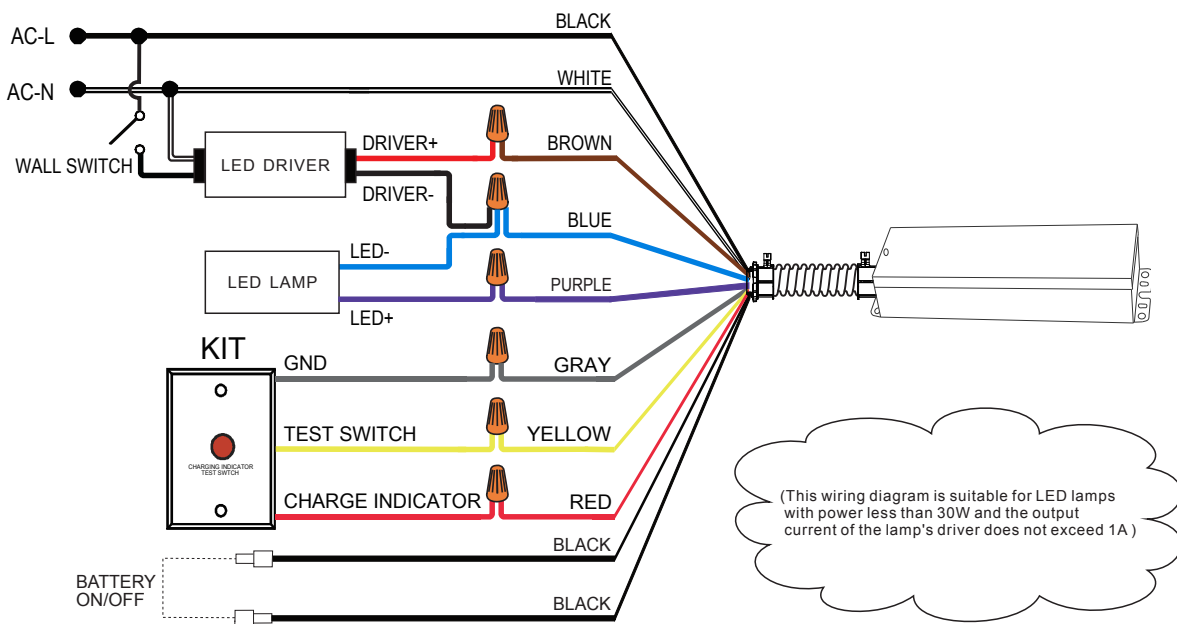

The wattage <120w wiring diagram





■ Product key components

	Material:	ADC12
	Sealing ring:	Silicone rubber
	Screw:	SUS304
	Color:	Yellow / Grey
	IP rating:	IP66
	Size:	125×80×57(mm)
	Weight:	0.15Kg



	Brand:	WAGO
	Model:	222-415
	Material:	Flame retardant PC
	Color:	Silver Grey
	Size:	20.5×17×14.5(mm)
	Voltage:	400V
	Current:	32A
	Surge voltage:	4KV
	Wire size:	1.0-2.5mm ²
Wire length:	8.0-10mm	

	Brand:	ViD
	Model:	UC05
	Material:	Flame retardant PC
	Color:	Clear
	Size:	29.8×20.5×10.5(mm)
	Voltage:	450V
	Current:	32A
	Wire size:	0.2-4.0mm ²
Wire length:	11mm	

	Model:	M25-2
	Material:	PA66
	Sealing ring:	Silicone rubber
	Thread size:	M25
	Wire size:	Round cable 3×2.5mm ²
	Color:	Black
	IP rating:	IP67

	Material:	SUS304
	Thread size:	2-G3/4
	Color:	Silver
	IP rating:	IP67
	Size:	30×30×40(mm)
	Weight:	0.06Kg

■ Accessories

Image	Product Code	Product Description
	SP-HR20	Hanging Ring
	SP-BS	Universal Bracket(Standard)



■ **Ordering Information**

