

Installation and Maintenance Manual

Stella Series LED Canopy Light

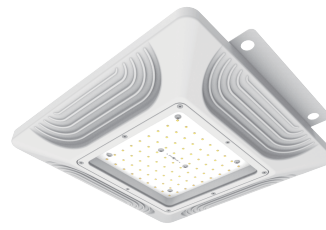

Introduction

Using only the highest quality components, the Corona Series LED Canopy Light Fixture is designed for industrial applications where reliability and performance are critical as the bulb maintenance is difficult or impossible, not to mention the high cost.

Every component of the Corona Series LED Canopy Light Fixture has been carefully engineered to provide the most reliable performance and bring across many benefits of utilizing solid state lighting technology in industrial applications.

Corona Series LED Canopy Light Fixture is rated IP66, suitable for both indoor and outdoor use.

Product Features:

- Individual high performance LED light engine with Philips Lumileds delivering 150 lumen per watt.
- Patented thermal management allows -30°C to 55°C ambient working temperature.
- Easiest installation and maintenance experiences guaranteed:
 - Easiest one-man operation;
 - Hinged LED light engine holder;
 - Quick connector between LED light engine and driver.
- 5 years warranty, up to 100,000 hours long life.
- Dimmable and motion sensor control compatible.

Warning

To avoid the risk of fire, explosion, or electric shock, this product should be installed, inspected, and maintained by a qualified electrician only, in accordance with all applicable electrical codes.

To avoid electric shock:

- Be certain electrical power is OFF before and during installation and maintenance.
- Luminaire must be connected to a wiring system with an equipment-grounding conductor.
- Make sure the supply voltage is the same as the rated luminaire voltage.
- Do not operate in ambient temperatures above those indicated on the luminaire nameplate.
- Avoid to use in environments containing sulfur, chlorine, or other halides, methyl acetate or ethyl acetate, cyanoacrylates, glycol ethers, formaldehyde or butadiene.

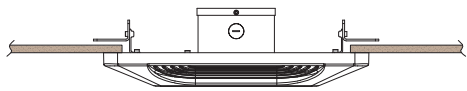
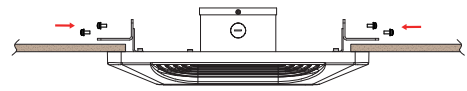
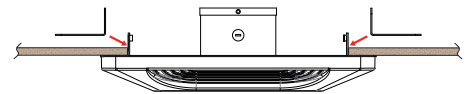
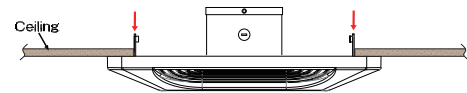

Installation

For high performance and long term reliability, the light should be installed in free air.

A. Recessed-in Installation

1. Bolt the anchor plate to the ceiling securely.
2. Hook the fixture to the anchor plate.
3. Insert the screw to secure the hook to the anchor plate.
4. Wiring.(Connect supply wires to luminaire wire leads per the wiring diagram using methods that comply with all applicable codes.)

Wiring

1. Connect supply wires to luminaire wire leads per the wiring diagram using methods that comply with all applicable codes.
2. Turn power on.

A. American Standard Power Cable

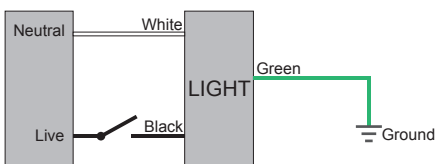

B. European Standard Power Cable

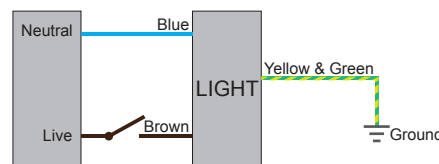

C. Australian Standard Power Cable

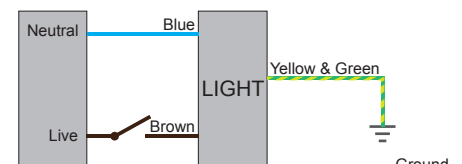

Specification

AC Voltage	100~277V	Power Frequency	50/60Hz
Working Temp.	-30~+55°C	Working Humidity	15%~90%RH
Storing Temp.	-40~+70°C	IP Rating	IP66

All statements, technical information and recommendations contained herein are based on information and tests we believe to be reliable. The accuracy or completeness thereof is not guaranteed.

Installation and Maintenance Manual

Corona Series LED Canopy Light



Introduction

Using only the highest quality components, the Corona Series LED Canopy Light Fixture is designed for industrial applications where reliability and performance are critical as the bulb maintenance is difficult or impossible, not to mention the high cost.

Every component of the Corona Series LED Canopy Light Fixture has been carefully engineered to provide the most reliable performance and bring across many benefits of utilizing solid state lighting technology in industrial applications.

Corona Series LED Canopy Light Fixture is rated IP66, suitable for both indoor and outdoor use.

Product Features:

- Individual high performance LED light engine with Philips Lumileds delivering 150 lumen per watt.
- Patented thermal management allows -30°C to 55°C ambient working temperature.
- Easiest installation and maintenance experiences guaranteed:
 - Easiest one-man operation;
 - Hinged LED light engine holder;
 - Quick connector between LED light engine and driver.
- 5 years warranty, up to 100,000 hours long life.
- Dimmable and motion sensor control compatible.

Warning

To avoid the risk of fire, explosion, or electric shock, this product should be installed, inspected, and maintained by a qualified electrician only, in accordance with all applicable electrical codes.

To avoid electric shock:

- Be certain electrical power is OFF before and during installation and maintenance.
- Luminaire must be connected to a wiring system with an equipment-grounding conductor.
- Make sure the supply voltage is the same as the rated luminaire voltage.
- Do not operate in ambient temperatures above those indicated on the luminaire nameplate.
- Avoid to use in environments containing sulfur, chlorine, or other halides, methyl acetate or ethyl acetate, cyanoacrylates, glycol ethers, formaldehyde or butadiene.

Installation

For high performance and long term reliability, the light should be installed in free air.

A. Surface Mount with Bracket

1. Bolt the anchor plate to the ceiling securely.
2. Hook the fixture to the anchor plate.
3. Insert the screw to secure the hook to the anchor plate.
4. Wiring. (Connect supply wires to luminaire wire leads per the wiring diagram using methods that comply with all applicable codes.)

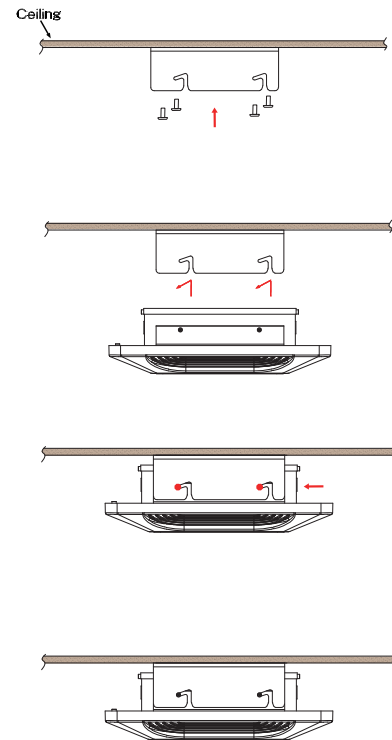

Wiring

1. Connect supply wires to luminaire wire leads per the wiring diagram using methods that comply with all applicable codes.
2. Turn power on.

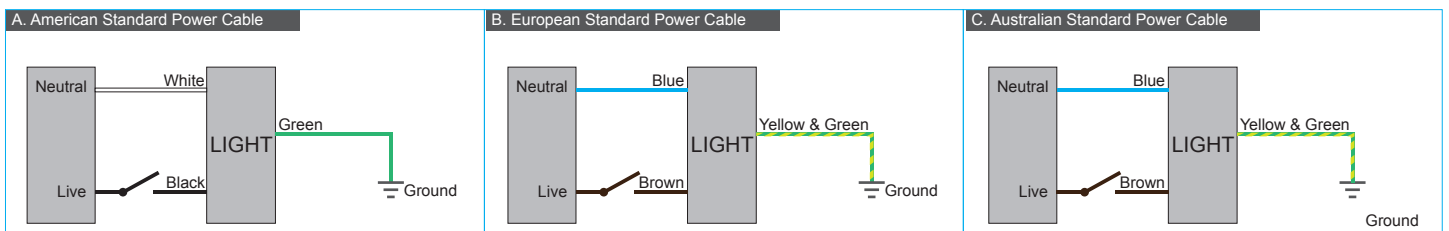

Specification

AC Voltage	100~277V	Power Frequency	50/60Hz
Working Temp.	-30~+55°C	Working Humidity	15%~90%RH
Storing Temp.	-40~+70°C	IP Rating	IP66

All statements, technical information and recommendations contained herein are based on information and tests we believe to be reliable. The accuracy or completeness thereof is not guaranteed.

Installation and Maintenance Manual

Corona Series LED Canopy Light



Introduction

Using only the highest quality components, the Corona Series LED Canopy Light Fixture is designed for industrial applications where reliability and performance are critical as the bulb maintenance is difficult or impossible, not to mention the high cost.

Every component of the Corona Series LED Canopy Light Fixture has been carefully engineered to provide the most reliable performance and bring across many benefits of utilizing solid state lighting technology in industrial applications.

Corona Series LED Canopy Light Fixture is rated IP66, suitable for both indoor and outdoor use.

Product Features:

- Individual high performance LED light engine with Philips Lumileds delivering 150 lumen per watt.
- Patented thermal management allows -30°C to 55°C ambient working temperature.
- Easiest installation and maintenance experiences guaranteed:
 - Easiest one-man operation;
 - Hinged LED light engine holder;
 - Quick connector between LED light engine and driver.
- 5 years warranty, up to 100,000 hours long life.
- Dimmable and motion sensor control compatible.

Warning

To avoid the risk of fire, explosion, or electric shock, this product should be installed, inspected, and maintained by a qualified electrician only, in accordance with all applicable electrical codes.

To avoid electric shock:

- Be certain electrical power is OFF before and during installation and maintenance.
- Luminaire must be connected to a wiring system with an equipment-grounding conductor.
- Make sure the supply voltage is the same as the rated luminaire voltage.
- Do not operate in ambient temperatures above those indicated on the luminaire nameplate.
- Avoid to use in environments containing sulfur, chlorine, or other halides, methyl acetate or ethyl acetate, cyanoacrylates, glycol ethers, formaldehyde or butadiene.

Installation

For high performance and long term reliability, the light should be installed in free air.

A. Surface Mount with Conduit

1. Bolt the anchor plate to the ceiling securely.
2. Hook the fixture to the anchor plate.
3. Insert the screw to secure the hook to the anchor plate.
4. Wiring.(Connect supply wires to luminaire wire leads per the wiring diagram using methods that comply with all applicable codes.)

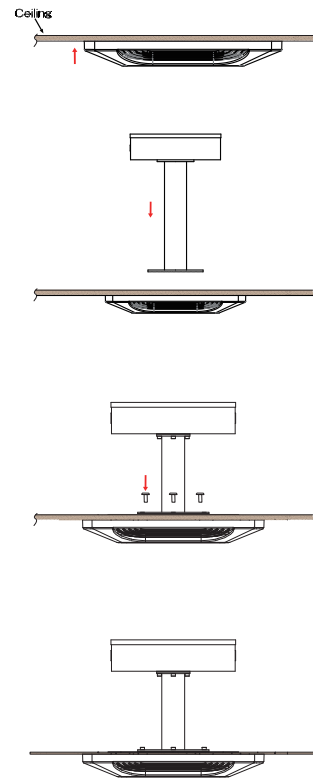

Wiring

1. Connect supply wires to luminaire wire leads per the wiring diagram using methods that comply with all applicable codes.
2. Turn power on.

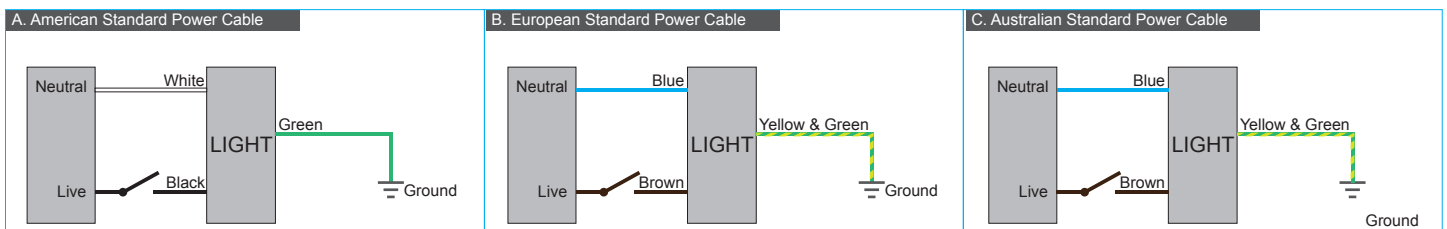

Specification

AC Voltage	100~277V	Power Frequency	50/60Hz
Working Temp.	-30~+55°C	Working Humidity	15%~90%RH
Storing Temp.	-40~+70°C	IP Rating	IP66

All statements, technical information and recommendations contained herein are based on information and tests we believe to be reliable. The accuracy or completeness thereof is not guaranteed.